



European Technical Assessment **ETA 12/0526** of 25/4/2022

I General Part

Technical Assessment Body issuing the ETA	Eurofins Expert Services Oy LTD
Trade name of the construction product	RR, RRs, RD and RDs piles
Product family to which the construction product belongs	Structural steel piles with hollow sections and rigid splices
Manufacturer	SSAB Europe Oy Harvialantie 420 FI-13300 Hämeenlinna Finland
Manufacturing plant	SSAB Europe Oy Pulkkila works, Hämeenlinna works, Lappohja works, Oulainen Works SSAB Europe Oy, Hämeenlinna
This European Technical Assessment contains	17 pages including 4 Annexes which form an integral part of this assessment
This European Technical Assessment is issued in accordance with regulation (EU) No 305/2011, on the basis of	European Assessment Document 200005-00-0103, edition December 2014.
This ETA replaces	ETA 12/0526, issued at 15/12/2020

Translations of this European Technical Assessment in other languages shall fully correspond to the original issued document and should be identified as such.

Communication of this European Technical Assessment, including transmission by electronic means, shall be in full excepted the confidential Annex(es) referred to above. However, partial reproduction may be made, with the written consent of the issuing Technical Assessment Body. Any partial reproduction has to be identified as such.

This European Technical Assessment may be withdrawn by the issuing Technical Assessment Body, pursuant to information by the Commission according to Article 25 Paragraph 3 of Regulation (EU) No 305/2011.

II Specific Part

1 Technical description of the product

RR, RRs, RD and RDs steel pile consist of a hollow section structural steel pipe. Pile may also include mechanical joints (external friction splice or threaded splice) or welded joints, a pile tip (rock shoe or bottom plate), a bearing plate or other additional accessories. Steel grades used in RR and RD pile pipes are S355J2H, S355MH, S420MH, S440J2H, S440MH and S460MH. Steel grades used in RRs and RDs pile pipes are S550J2H and S550MH. Steel grades S355J2H, S355MH, S420MH and S460MH are according to EN 10219-1. Chemical composition and mechanical properties of steel grades S440J2H, S440MH, S550J2H and S550MH are presented in annex 2.

Diameters of the piles spliced by mechanical splice are generally from 76.1 mm to 406,4 mm and wall thicknesses from 6.3 mm to 12.5 mm. Diameters of the piles spliced by welding on site are from 76.1 mm to 1220.0 mm and wall thicknesses from 6.3 mm to 23 mm. Splice welds made on site are not part of this ETA.

Mechanical joint used in RR and RRs piles is external friction splice sleeve where connection is based on friction and conical contact surfaces. Mechanical joint used in RD and RDs piles is based on threads and has either threaded splice sleeve or threaded male-female splice.

The piles may be equipped with a pressure-distributing bearing plate consisting of steel plate and plate concentrator. Bearing plate can be with or without holes.

Bottom plate and rock shoe, used in RR and RRs piles, are pile tips which are fastened to the lower end of the pile mechanically with friction and conical surface or fastened by welding. Rock shoe is additionally equipped with a dowel made of structural or hardened steel.

Pile tip can also have expander head which makes shaft grouting possible. The installation procedures of the shaft grouted pile and grouting materials are not part of the ETA.

Dimensions of piles, pile components and accessories are presented in annexes 3 and 4.

RR piles and RRs piles are installed by driving (impact driving, jacking, vibrating, screwing) and RD and RDs piles by drilling. Drilling system components are not part of the ETA.

Completed piles and design and installation procedures (execution) of the completed piles are not covered by this ETA.

2 Specification of the intended uses in accordance with the applicable EAD

Intended uses

RR, RRs, RD and RDs piles are used as the foundation piles in all kind of structures where the pile foundations are needed e.g. buildings, bridges, harbours or traffic structures. The piles are designed generally as an end bearing piles but designing as a shaft bearing pile is also possible. Products can be also used as a part of retaining wall according to EN 12063. The piles are designed for loading by axial forces or horizontal forces or combined loads. If the pile is under considerable cyclical stress they must be taken into account separately.

The provisions made in this ETA are based on an assumed working life of the piles of 100 years depending of chosen material thickness and environmental conditions which are

defined in Eurocode EN 1993-5 paragraph 4.4. The indications given on the working life cannot be interpreted as a guarantee given by the producer, but are to be regarded only as a means for choosing the right products in relation to the expected economically reasonable working life of the works.

Design

Maximum compression resistance of the pile pipes cross-section are presented in tables 2a and 2b. Geotechnical and structural load bearing resistance of the steel pipe pile shall be dimensioned according to valid EN standards and/or national regulations. If the pile is mechanically spliced the characteristics mentioned in point 3 shall be taken into account.

The designing of pile tips, bearing plates and other accessories shall be carried out taking into account the characteristics of connected structures, EN standards and/or national regulations. Informative load bearing resistances of standard pile tips and bearing plates for RR, RRs, RD and RDs piles are presented in manufacturer's design manual.

The designing of completed piles is not covered by this ETA. The design of the completed piles is subjected to national requirements and regulations.

Execution of construction works

It is the responsibility of the manufacturer to ensure that proper information for the use of the RR, RRs, RD and RDs piles is enclosed to each delivery, including general guidance on the basis of this ETA and the specific installation instructions and construction details. The manufacturer shall provide with written documents which contain descriptions about type and frequency of the maintenance.

The completed building (the works) shall comply with the building regulations (regulations on the works) applicable in the Member States in which the building is to be constructed. The procedures foreseen in the Member State for demonstrating compliance with the building regulations shall also be followed by the entity held responsible for this act. An ETA for a RR, RRs, RD and RDs piles does not amend this process in any way.

3 Performance of the product and references to the methods used for its assessment

Table 1. Basic requirements for construction works and essential characteristics

Basic requirement and essential characteristics	Performance
BWR 1. Mechanical resistance and stability	
Bending resistance and stiffness	Bending stiffness of the pile with mechanical pile joint: $EI_{\text{spliced}} \geq 0,75 \times EI_{\text{unspliced}}$ (in moment range 0.3 - 0.8 x M) Bending resistance of the pile with mechanical pile joint: $M_{\text{spliced}} = W \times f_y$
Tension resistance	Tension resistance of the pile with mechanical pile joint: $N_{t,\text{spliced}} \geq 0.15 \times A_s \times f_y$
Compression resistance	Compression resistance of the pile with mechanical pile joint: $N_{c,\text{spliced}} \geq A_s \times f_y$
Robustness of pile joints	Driven pile: Impact blow test with stress level of $0.75 \times f_y$ ¹⁾ Drilled pile: Mechanical joint tightening test with moment ≥ 1 kNm
Material properties and dimensional tolerances	Material properties: -pile pipe; Annex 2 and EN10219 -pile components; EN10219, EN10294, EN10297, EN10025, EN10083, EN10248 Dimensional tolerances: -pile pipe and external sleeve splice pipe; Annex 3 -pile components; EN 22768-1, tolerance class medium Testing of material properties and controlling of dimensional tolerances of pipe according to EN10219
Resistance to corrosion	The reduced load bearing capacities of pile pipes in consideration of thickness losses due to corrosion set in EN 1993-5 shall be calculated according to valid EN standards or national regulations.
BWR 2. Safety in case of fire	
Reaction to fire of materials and components	Class A1, according to EN 13501-1

¹⁾ Amount of impacts is 500 when mass of ram is at least 20 times higher than meter-mass of pile

EI = bending stiffness of pile pipe ($EI_{\text{unspliced}}$ can be calculated according EN1993-5 or tested)

M = bending moment, characteristic value

W = pile tube section modulus

A_s = cross-sectional area of steel pile pipe

f_y = yield strength of pile pipe

4 Assessment and verification of constancy of performance (hereinafter AVCP) system applied, with reference to its legal base

For the products covered by this ETA the applicable European legal act is: Decision 1999/94/EC

The system is: 2+

5 Technical details necessary for the implementation of the AVCP system, as provided for in the applicable EAD.

Technical details necessary for the implementation of the AVCP system are laid down in the control plan deposited at Eurofins Expert Services Oy Ltd.

Issued in Espoo on 25 April, 2022
by Eurofins Expert Services Oy Ltd

Tiina Ala-Outinen
Manager, Building structures

Samuli Korhikoski
Senior Expert

Product range of RR, RRs, RD and RDs piles

Mechanically spliced RR, RRs, RD and RDs piles fulfill the requirements set in point 3. Compression strength of mechanically spliced RR, RRs, RD and RDs pile equals maximum compression resistance of pile presented in tables 2a and 2b.

Tension resistance of the RR, RRs, RD and RDs pile with mechanical splice is at least 15 % of the compression resistance of pile presented in table 2a and 2b.

The maximum resistance value shown in the cells in table 2a and 2b are calculated as:

$$N_c = \frac{A_s \times f_y}{\gamma_m}$$

, where

A_s = nominal cross-sectional area of steel pipe

f_y = nominal yield strength of pile pipe

$\gamma_m = 1,0$

Geotechnical and structural load bearing capacity of the steel pipe pile shall be dimensioned according to valid EN standards and/or national regulations.

Table 2a Pile types, dimensions and maximum resistances						
RR and RRs piles						
Pile	Diameter [mm]	Wall thickness [mm]	Steel grade			
			S355	S440	S460	S550
RR75	76.1	6.3		608 kN	635 kN	
RR90	88.9	6.3		719 kN	752 kN	
RRs100	101.6	6.3				1037 kN
RR/RRs115	114.3	6.3		941 kN	983 kN	
		8.0		1176 kN	1229 kN	1469 kN
RRs125	127.0	6.3				1313 kN
RR/RRs140	139.7	8.0		1456 kN	1523 kN	1820 kN
		10.0		1793 kN	1874 kN	2241 kN
RR/RRs170	168.3	10.0		2188 kN	2288 kN	2735 kN
		12.5		2692 kN	2814 kN	3365 kN
RR/RRs220	219.1	10.0		2890 kN	3022 kN	3613 kN
		12.5		3570 kN	3732 kN	4460 kN
RR/RRs245	244.7	10.0			3392 kN	4055 kN
		12.5			4194 kN	5015 kN
RR/RRs270	273.0	10.0	2933 kN	3635 kN	3801 kN	4544 kN
		12.5	3632 kN	4501 kN	4706 kN	5626 kN
RR320 ¹⁾	323.9	10.0	3501 kN	4339 kN	4536 kN	5424 kN
		12.5	4341 kN	5381 kN	5625 kN	6726 kN
RD and RDs piles						
Pile	Diameter [mm]	Wall thickness [mm]	Steel grade			
			S355	S440	S460	S550
RD/RDs90	88.9	6.3		719 kN	752 kN	899 kN
RDs100 ¹⁾	101.6	6.3				1037 kN
RD/RDs115	114.3	6.3		941 kN	983 kN	1176 kN
		8.0		1176 kN	1229 kN	1469 kN
RDs125 ¹⁾	127.0	6.3				1313 kN
RD/RDs140	139.7	8.0		1456 kN	1523 kN	1820 kN
		10.0		1793 kN	1874 kN	2241 kN
RD/RDs170	168.3	10.0		2188 kN	2288 kN	2735 kN
		12.5		2692 kN	2814 kN	3365 kN
RD/RDs220	219.1	10.0		2890 kN	3022 kN	3613 kN
		12.5		3570 kN	3732 kN	4460 kN
RD/RDs270	273.0	10.0	2933 kN	3635 kN	3801 kN	4544 kN
		12.5	3632 kN	4501 kN	4706 kN	5626 kN
RD/RDs320	323.9	10.0	3501 kN	4339 kN	4536 kN	5424 kN
		12.5	4341 kN	5381 kN	5625 kN	6726 kN

1) Only structural steel piles without joints

Table 2b Pile types, dimensions and maximum resistances

Pile	Diameter	Wall thickness								
		8	10	12,5	14,2	16	18	20	22	23
	[mm]									
RR/RD400	406,4	S355: 3555 kN	S355: 4421kN	S355: 5491 kN ¹⁾						
RR/RD450	457,0	S355: 4006 kN	S355: 4985kN	S355: 6197 kN						
RR/RD500	508,0	S355: 4461 kN	S355: 5554kN	S355: 6908 kN	S355: 7820 kN	S355: 8779 kN				
RR/RD550	559,0	S355: 4916kN	S355: 6123 kN	S355: 7619 kN	S355: 8628 kN	S355: 9689 kN				
RR/RD600	610,0	S355: 5371kN	S355: 6692kN	S355: 8330 kN	S355: 9436 kN	S355: 10599 kN	S355: 11884 kN			
RR/RD650	660,0	S355: 5817kN	S355: 7249kN	S355: 9027 kN	S355: 10227 kN	S355: 11492 kN	S355: 12888 kN			
RR/RD700	711,0	S355: 6272kN	S355: 7818kN	S355: 9738 kN	S355: 11035 kN	S355: 12402 kN	S355: 13912 kN	S355: 15413 kN		
RR/RD750	762,0	S355: 6727kN	S355: 8387kN	S355: 10449 kN	S355: 11843 kN	S355: 13312 kN	S355: 14936 kN	S355: 16551 kN		
RR/RD800	813,0	S355: 7182kN	S355: 8956kN	S355: 11160 kN	S355: 12650 kN	S355: 14222 kN	S355: 15959 kN	S355: 17688 kN	S355:19408 kN	S355:20264 kN
RR/RD900	914,0	S355: 8083kN	S355: 10082kN	S355: 12568 kN	S355: 14250 kN	S355: 16024 kN	S355: 17987 kN	S355: 19941 kN	S355: 21886kN	S355: 22855 kN
RR/RD1000	1016,0	S355: 8994kN	S355: 11220kN	S355: 13990 kN	S355: 15865 kN	S355: 17844 kN	S355: 20035 kN	S355: 22216 kN	S355: 24389kN	S355: 25471 kN
RR/RD1200	1220,0	S355: 10814kN	S355: 13495kN	S355: 16834 kN	S355: 19096 kN	S355: 21484 kN	S355: 24130 kN	S355: 26766 kN	S355: 29394kN	S355: 30704 kN
	Steel grade S355J2H, S355MH, S440J2H, S440MH, S460MH, S550J2H and S550MH									
	Steel grade S355J2H, S355MH, S440J2H, S440MH and S460MH									

Note: The maximum resistance values are presented only for steel grade S355 in the cells. The maximum resistance values for other steel grades S440, S460 and S550 can be calculated as described in this annex.

Note: Only the most common RR and RD pile diameters and wall thicknesses are presented in table but also other diameters and wall thicknesses are available.

1) Including threaded pile joint up to S550 steel grade

Chemical composition of S440J2H, S440MH, S550J2H and S550MH steel grades

Table 3. Chemical composition – Cast analysis for product thickness ≤ 20 mm

Steel grade	Type of deoxidation ^a	% by mass, maximum					
		C	Si	Mn	P	S	N ^b
S440J2H	FF	0,18	0,50	1,70	0,025	0,020	-
S550J2H	FF	0,16	0,50	2,20	0,030	0,030	-

^a The deoxidation method is designated as follows:
FF: Fully killed steel containing nitrogen binding elements in amounts sufficient to bind available nitrogen (e.g. min. 0,020 % total Al or 0,015 % soluble Al).

^b The maximum value for nitrogen does not apply if the chemical composition shows a minimum total Al content of 0,020 % with a minimum Al/N ratio of 2:1, or if sufficient other N-binding elements are present. The N-binding elements shall be recorded in the Inspection Document.

Table 4. Mechanical properties of non-alloy steel hollow sections in thicknesses ≤ 20 mm

Steel grade	Minimum yield strength R_{eH} MPa	Tensile strength R_m MPa	Minimum elongation A^a %	Minimum impact energy KV^b J		
	Specified thickness mm	Specified thickness mm	Specified thickness mm	at test temperature of		
	≤ 20	≤ 20	≤ 20	-20°C	0 °C	20 °C
S440J2H	440	490-630	17	27	-	-
S550J2H	550	605-760	14	27		-

^a For pile sizes $D/T < 15$ (circular) the minimum elongation is reduced by 2

^b For impact properties for reduced section test pieces see 6.7.2. EN 10219-1

Table 5. Chemical composition - Cast analysis for product thicknesses ≤ 20 mm, feedstock condition M^a

Steel grade	Type of deoxidation ^b	Classification ^c	% by mass											
			C max.	Si max.	Mn max.	P max.	S max.	Nb max.	V max.	Al _{total} ^d min.	Ti max.	Ni max.	Mo ^e max.	N max.
S440MH	GF	SS	0,16	0,50	1,70	0,025	0,020	0,050	0,12	0,020	0,050	0,30	0,20	0,025
S550MH	GF	SS	0,14	0,50	2,00	0,025	0,020	0,050	0,12	0,020	0,050	0,30	0,20	0,025

^a See 6.3. EN 10219-1

^b The deoxidation method is designated as follows:
GF = Fully killed steel containing nitrogen binding elements in amounts sufficient to bind the available nitrogen and having a fine grained structure.

^c SS = special steel.

^d If sufficient N-binding elements are present, the minimum total Al content does not apply.

^e The total sum of Cr, Cu and Mo shall not be higher than 0,60 %.

Table 6. Mechanical properties of hollow sections in thicknesses ≤ 20 mm – Feedstock material condition M

Steel grade	Minimum yield strength R_{eH} MPa	Tensile strength R_m MPa	Minimum elongation A^a %	Minimum impact energy KV ^b J	
	Specified thickness mm	Specified thickness mm	Specified thickness mm	At test temperature of	
	≤ 20	≤ 20	≤ 20	-50°C	-20 °C
S440MH	440	490-630	17	-	40°
S550MH	550	605-760	14	-	40°

^a For pile sizes $D/T < 15$ (circular) the minimum elongation is reduced by 2
^b For impact properties for reduced section test pieces see 6.7.2. EN 10219-1
^c This value corresponds to 27 J at -30 °C (see EN 1993-1-1).

Table 7. Maximum carbon equivalent value (CEV) based on cast analysis ^a

Steel grade	Maximum CEV for nominal thicknesses ≤ 20 mm %
S440J2H	0,45
S550J2H	0,47
S440MH	0,42
S550MH	0,45

^a See 6.6.2 EN 10219-1, Option 1.2.

Mechanical properties of pile and sleeve pipes

Table 8. Tolerances on shape and mass, pile pipe

Characteristic	Circular hollow section
Outside diameter (D)*	D ≤ 350 mm ± 0,5 % D > 350 mm ± 1%
Thickness (T)	For D ≤ 406,4 mm: T ≤ 5 mm ± 10 % T > 5 mm ± 0,5 mm For D > 406,4 mm: ± 10 % with a maximum of ± 2 mm
Out-of-roundness (O)	D ≤ 150 mm ± 1,2% D > 150 mm, D ≤ 350 mm ± 1% D > 350 mm ± 2%
Straightness (e)	0,20 % of total length
Mass per unit length (M)	± 6 % on individual delivered lengths
*The diameter (D) shall be measured by circumference tape at the discretion of the manufacturer.	

Table 9, Tolerances on shape and mass, sleeve pipe (friction joint)

Characteristic	Circular hollow section
Inside diameter (D)*	D ≤ 150 mm ± 0,5 % D > 150 mm ± 0,3 %
Thickness (T)	For D ≤ 406,4 mm: T ≤ 5 mm ± 10 % T > 5 mm ± 0,5 mm For D > 406,4 mm: ± 10 % with a maximum of ± 2 mm
Out-of-roundness (O) **	D ≤ 150 mm ± 1,2 % D > 150 mm ± 1 %
Straightness (e)	0,20 % of total length
Mass per unit length (M)	± 6 % on individual delivered lengths
Length of individual sleeve (L)	± 5 mm
*The diameter (D) shall be measured by circumference tape at the discretion of the manufacturer. ** The out-of-roundness (O) can be measured from blank sleeve pipe or from final product.	

Principle drawing of RD pile.

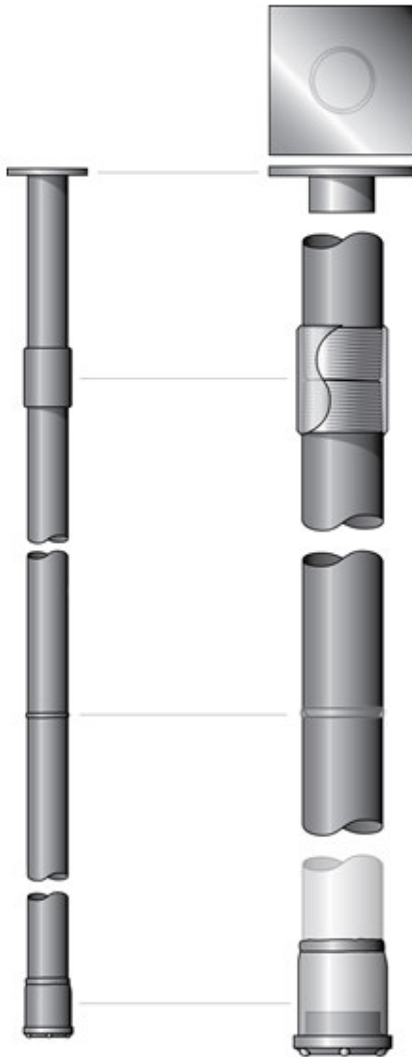

Bearing plate:

- Typically used in RD and RDs piles RD90 - RD320.

Threaded sleeve splice:

- Used in RD and RDs piles RDT90 – RDT400 and RDTs90 – RDTs400.

Welded splice

- Used in RD and RDs piles RD90 - RD1200.

Drilling system components are not part of the ETA. Drilling system components attached to the lower end of the pile according to the instructions of drilling system manufacturer.

Principle drawing of RR pile.

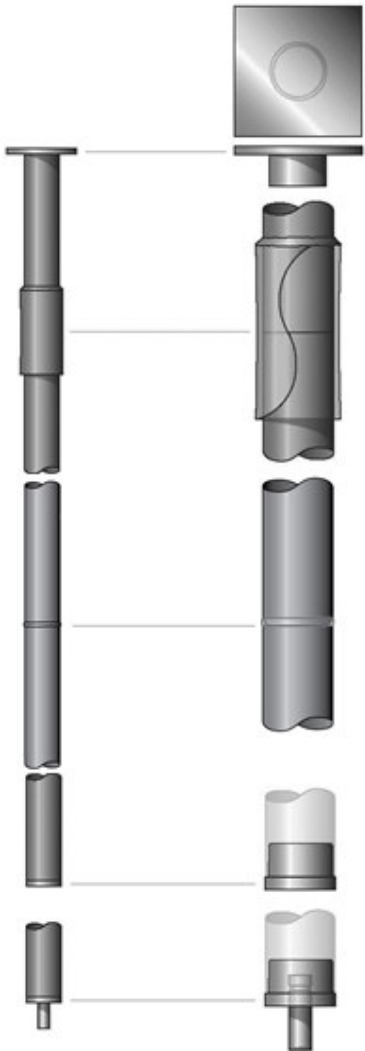

Bearing plate:

- Typically used in RR and RRs piles RR75 - RR320.

External sleeve splice:

- Used in RR and RRs piles RR75 - RR270.

Welded splice:

- Used in RR and RRs piles RR75 - RR1200.

Bottom plate:

- Typically used in RR piles RR75 - RR320.

Rock shoe:

- Typically used in RR piles RR75 - RR1200.



Rock shoe with hardened dowel:

- Piles RR75 – RR320



Rock shoe with hardened dowel:

- Piles RR270 – RR1200



Rock shoe with structural steel dowel:

- Piles RR400 – RR1200



Rock shoe with hollow dowel:

- Piles RR400 – RR1200

The main dimensions of standard pile tips, bearing plates and splice sleeves.

More detailed information is presented in manufacture's product description and design manual.

Rock shoe				
Pile	D	L	D1	L1
RR75/6,3	75	99	30	49
RR90/6,3	90	99	30	49
RR115/6,3	115	135	40	65
RR115/8	115	145	50	65
RR125/6,3	125	145	50	65
RR140/8	140	195	59.5	95
RR140/10	140	205	59.5	95
RR170/10	170	215	69.5	95
RR170/12,5	170	215	59.5	95
RR220/10	220	274	79.5	124
RR220/12,5	220	274	79.5	124

Rock shoe, Next Generation				
Pile	D	L	D1	L1
RR100/6.3	100	94	40	54
RR115/6,3	115	107	50	67
RR115/8	115	107	50	67
RR125/6,3	125	107	50	67
RR140/8	140	120	59.5	70
RR140/10	140	120	59.5	70
RR170/10	170	160	59.5	95
RR170/12,5	170	160	59.5	95
RR220/10	220	199	79.5	124
RR220/12,5	220	199	79.5	124
RR245/10	250	259	95	154
RR245/12,5	250	259	95	154
RR270/10	280	264	95	154
RR270/12,5	280	264	95	154
RR320/10	330	305	120	195
RR320/12,5	330	305	120	195

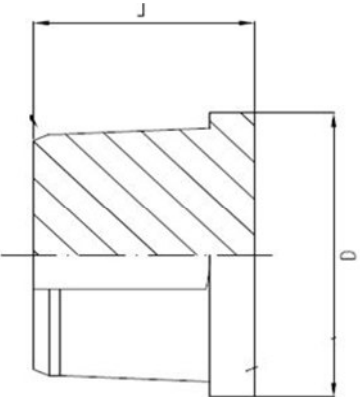
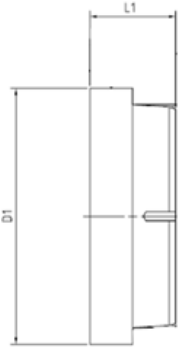
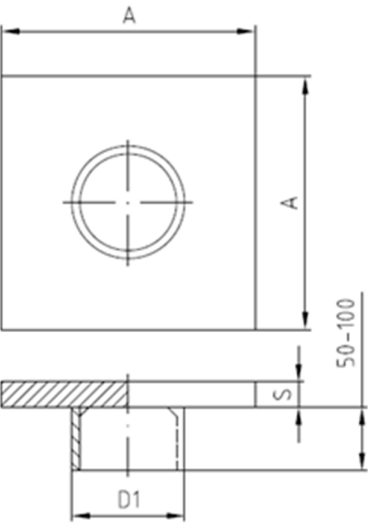
	Bottom plate			
	Pile	D	L	
	RR75/6,3	75	50	
	RR90/6,3	90	50	
	RR115/6,3	115	70	
	RR115/8	115	70	
	RR125/6.3	125	80	
	RR140/8	140	100	
	RR140/10	140	100	
	RR170/10	170	110	
	RR170/12,5	170	110	
	RR220/10	220	150	
	RR220/12,5	220	150	
	Bottom plates Next Generation			
	Pile	D1	L1	
	RR100/6.3	100	40	
	RR115/6,3	115	40	
	RR115/8	115	40	
	RR125/6,3	125	40	
	RR140/8	140	50	
	RR140/10	140	50	
	RR170/10	170	65	
	RR170/12,5	170	65	
	RR220/10	220	75	
	RR220/12,5	220	75	
	RR245/10	250	105	
	RR245/12.5	250	105	
	RR270/10	280	110	
RR270/12,5	280	110		
RR320/10	330	110		
RR320/12,5	330	110		
	Bearing plate			
	Pile	Pile steel grade	D1	AxAxS
	RR75/6,3	S440/S460/S550	60,3	150x150x15
	RR90/6,3	S440/S460/S550	60,3	150x150x15
	RR100/6.3	S550	60.3	200x200x20 200x200x25
	RR115/6,3	S440/S460/S550	88,9	200x200x20
	RR115/8	S440/S460/S550	88,9	250x250x25
	RR125/6,3	S550	88,9 88,9	200x200x20 250x250x25
	RR140/8	S440/S460/S550	114,3	250x250x25
	RR140/10	S440/S460/S550	114,3	250x250x25
	RR170/10	S440/S460/S550	114,3	300x300x30
	RR170/12,5	S440/S460/S550	114,3	300x300x30
	RR220/10	S440/S460/S550	139,7-168,3	300x300x30
	RR220/12,5	S440/S460	139,7-168,3	300x300x30
	RR220/12,5	S550	139,7-168,3	350x350x35
RR245/10	S440/S460/S550	193.7	300x300x30	
RR245/12.5	S440/S460	193.7	300x300x30	

	RR245/12,5	S550	193,7	350x350x35
	RR270/10	S440/S460	219,1	350x350x30
	RR270/12,5	S440/S460	219,1	350x350x30
	RR320/10	S440/S460	219,1	400x400x30
	RR320/12,5	S440/S460	219,1	400x400x30
	RR270/10	S550	219,1	400x400x30
	RR270/12,5	S550	219,1	450x450x40
	RR320/10	S550	219,1	450x450x40
	RR320/12,5	S550	219,1	500x500x40

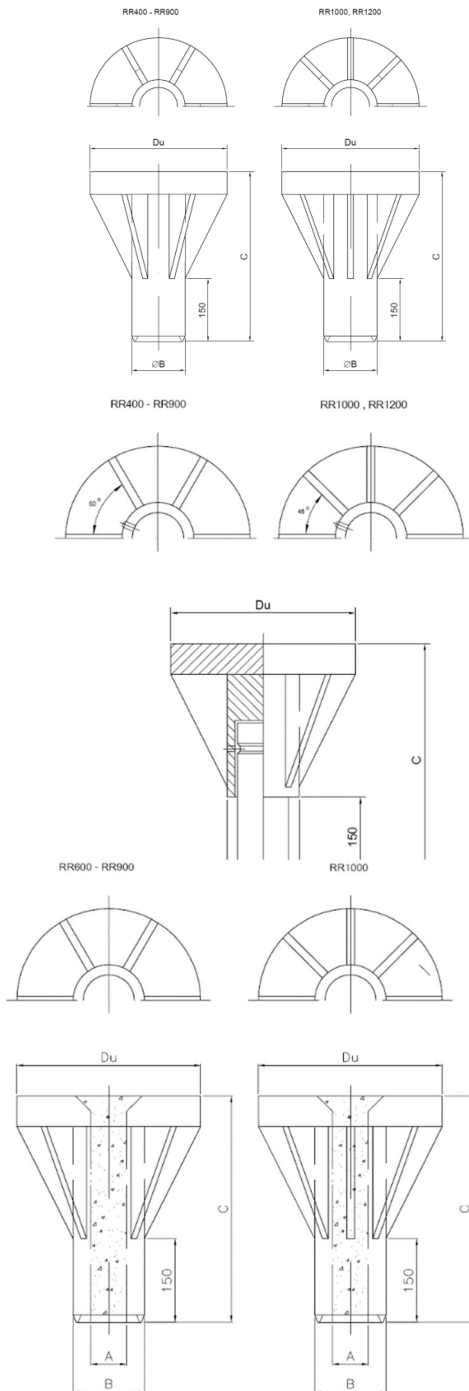

Rock shoe with structural steel dowel				
Pile	D	Du	B	C
RR400	406,4	408	140	450
RR450	457,0	459	150	470
RR500	508,0	510	170	540
RR550	559,0	561	180	600
RR600	610,0	612	200	640
RR650	660,0	662	210	710
RR700	711,0	713	210	730
RR750	762,0	764	220	800
RR800*	813,0	815	240	840
RR900*	914,0	916	240	940
RR1000*	1016,0	1018	260	1080
RR1200*	1220,0	1222	280	1230

The load for pile pipe limited, if $s=22$ mm and $f_y>440$ MPa and if $s=23$ mm and $f_y>420$ MPa
 s is the wall thickness of pile pipe

Rock shoe with hardened dowel					
Pile	D	Du	A	B	C
RR270	273,0	275	99	130	277
RR320	323,0	325	99	130	277
RR400	406,4	408	100	140	470
RR450	457,0	459	110	150	490
RR500	508,0	510	120	170	560
RR550	559,0	561	125	180	620
RR600	610,0	612	140	200	660
RR650	660,0	662	150	210	730
RR700	711,0	713	150	210	750
RR750	762,0	764	160	220	820
RR800*	813,0	815	165	240	860
RR900*	914,0	916	180	240	960
RR1000*	1016,0	1018	180	260	1100
RR1200*	1220,0	1222	200	280	1250

The load for pile pipe limited, if $s=22$ mm and $f_y>440$ MPa and if $s=23$ mm and $f_y>420$ MPa
 s is the wall thickness of pile pipe

Rock shoe with hollow dowel					
Pile	D	Du	A	B	C
RR600	610,0	612	119,1	219,1	640
RR700	711,0	713	144,5	244,5	730
RR800	813,0	815	124,5	244,5	840
RR900	914,0	916	117,0	267,0	940
RR1000	1016,0	1018	148,5	298,5	1080

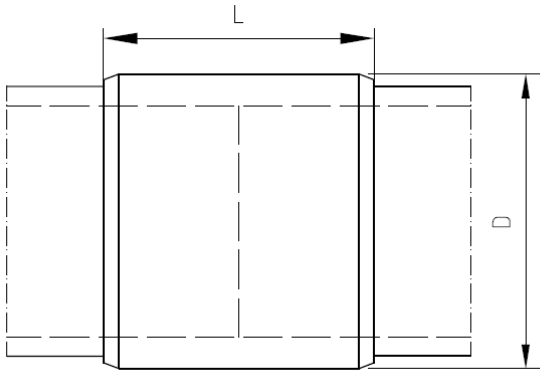

RDT threaded sleeve splice			RDTs threaded sleeve splice		
Pile	min. D	L	Pile	min. D	L
RDT90/6.3	101.6	160	RDTs90/6.3	101.6	160
RDT115/6.3	126.9	160	RDTs115/6.3	126.9	160
RDT115/8	126.9	160	RDTs115/8	126.9	160
RDT140/8	152.4	160	RDTs140/8	152.4	160
RDT140/10	152.4	160	RDTs140/10	152.4	160
RDT170/10	181.9	200	RDTs170/10	181.9	200
RDT170/12.5	181.9	200	RDTs170/12.5	181.9	200
RDT220/10	234.9	200	RDTs220/10	234.9	200
RDT220/12.5	234.9	200	RDTs220/12.5	234.9	200
RDT270/10	292	200	RDTs270/10	292	200
RDT270/12.5	292	200	RDTs270/12.5	292	200
RDT320/10	343	220	RDTs320/10	343	220
RDT320/12.5	343	220	RDTs320/12.5	343	220
RDT400/12.5	431,8	320	RDTs400/12.5	431,8	320

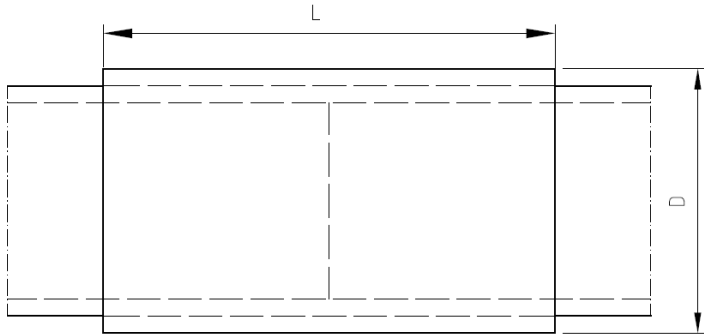

RR friction sleeve splice		
Pile	D	L
RR75/6,3	88,3*	200
RR90/6,3	101,1	240
RRs100/6.3	114.3	270
RR115/6,3	127,0	270
RR115/8	127,0	270
RRs115/8	126,3**	270
RRs125/6.3	139,7	300
RR140/8 RRs140/8	159,0	300
RR140/10, RRs140/10	159,0	300
RR170/10, RRs170/10	190,5	400
RR170/12,5, RRs170/12,5	190,5	400
RR220/10, RRs220/10	244.0	600
RR220/12.5, RRs220/12.5	244.0	600
RR245/10, RRs245/10	269.2	600
RR245/12,5, RRs245/12,5	269.2	600
RR270/10, RRs270/10	297,0	700
RR270/12,5, RRs270/12,5	297,0	700

* 88.9 mm if thickness of the sleeve tube wall is 6.8 mm
 ** 127.0 mm if thickness of the sleeve tube wall is 6.8 mm